

# Smooth Operator



**Structure:** metal.

**Seat upholstery:** expanded polyurethane of varied densities (D35EM+OS40M+D50 mind foam) covered with synthetic lining 6mm and 230gr.

**Arm and back upholstery:** expanded polyurethane of varied densities (HT45+40P+D35EM+D18CDSS) covered with downproof white cotton cover filled with 100% natural down.

**Seat height:** 42 cm

**Arm height:** 68 cm (minimum) – 85 cm (maximum).

**Feet:** metal, finishes black nickel or titanium or varnished micaceous brown or oxy grey, h.16,5 cm.

**On request feet can be supplied 3 cm higher by using spacers that may be at sight.**

**Attention:** please specify the fabric or leather colour of the back cushion stripes.

**Cleaning instructions:** if the stripes are covered with leather B 3155 - 3156 - 3157 - 3158, there is no cleaning procedure that can be used. For all the other leathers of Arketipo collection the cover can be dry cleaned in specialized laundries. If two fabrics have different cleaning procedures, please follow the most restrictive one.

**Struttura:** metallo.

**Imbottitura fusto seduta:** poliuretano espanso a quote differenziate (D35EM+OS40M+D50 mind foam) rivestito con accoppiato 6mm e Tomana 230gr.

**Imbottitura fusto braccioli e schienali:** poliuretano espanso a quote differenziate (HT45+40P+D35EM +D18CDSS) rivestito con cotone 100% antipiuma bianco riempito con piuma naturale 100%.

**Altezza seduta:** 42 cm

**Altezza bracciolo:** 68 cm (minima) – 85 cm (massima).

**Piedi:** metallo, finiture: black nickel o titanio oppure verniciato marrone micaceo o oxy grey, h.16,5 cm.

**Su richiesta al momento dell'ordine è possibile avere piedi più alti di 3 cm. previo inserimento di distanziali che potrebbero essere visibili.**

**Attenzione:** specificare il tessuto o la pelle delle fasce degli schienali.

**Istruzioni di lavaggio:** se per le fasce viene usata la Pelle B 3155 - 3156 - 3157 - 3158 il rivestimento non è lavabile né in acqua né a secco. Per le altre pelli del campionario Arketipo è possibile effettuare il lavaggio a secco presso lavanderie specializzate. Se vengono abbinati due tessuti con manutenzione diversa vanno seguite le norme più restrittive.

Back cushions marked with \* are supplied with a mechanism that allows three sitting positions. The other back cushions are supplied with a mechanism that allows four sitting positions.

Gli schienali evidenziati con il simbolo \* sono dotati di un meccanismo che permette tre posizioni di seduta. I restanti schienali sono dotati di un meccanismo che permette quattro posizioni di seduta.

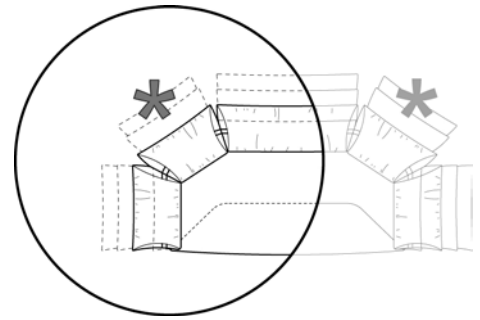

In order to avoid any damages to the mechanism, please DO NOT sit on armrests and backs.

Per evitare danni al meccanismo, si prega di NON sedersi sui braccioli e sugli schienali.



**Sofa**  
Divano

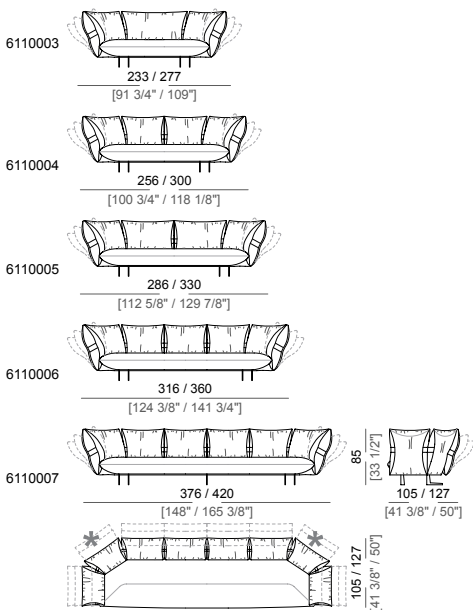

**Central unit**  
Elemento centrale

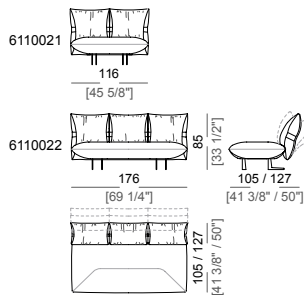

**Right or left unit**  
Laterale dx o sx

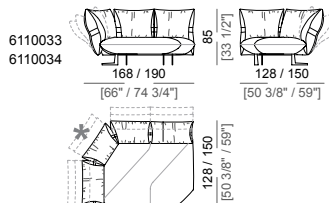

**Right or left unit**  
Elemento laterale dx o sx

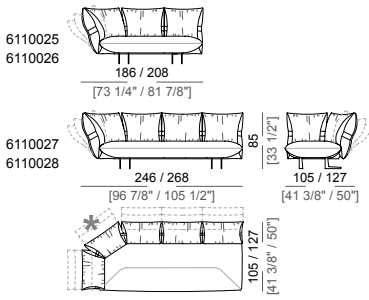

**Unit with right or left pouf**  
Laterale con pouf dx o sx

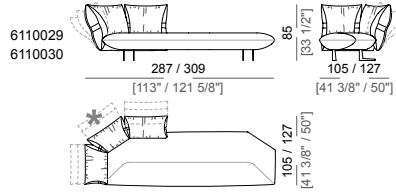

**Unit with right or left pouf**  
Laterale con pouf dx o sx

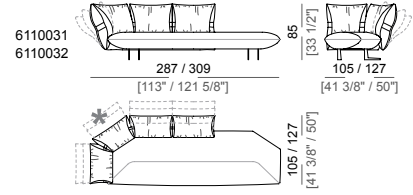

**Chaise longue with right or left short arm**  
Chaise longue dx o sx

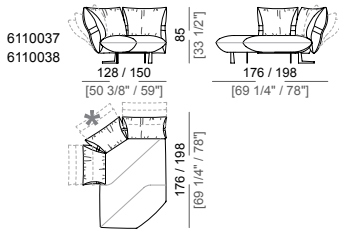

**Chaise longue with right or left long arm**  
Chaise longue dx o sx

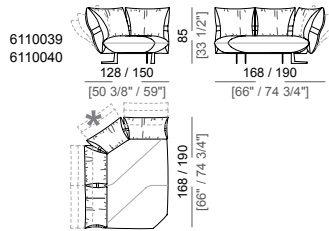

**Right or left dormeuse**  
Dormeuse dx o sx

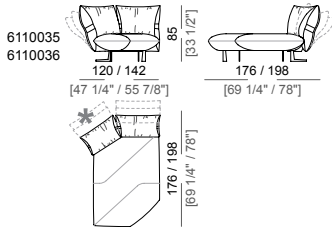

**Pouf**  
Pouf

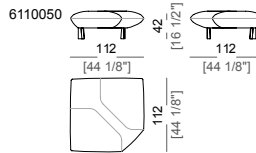

**Composition A**  
Composizione A

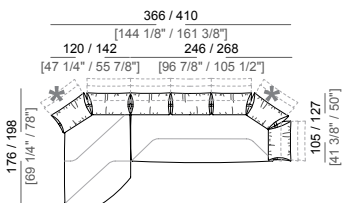

**Composition B**  
Composizione B

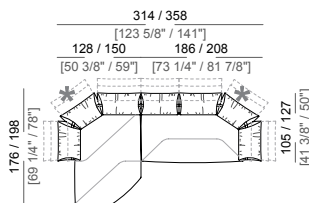

**Composition C**  
Composizione C

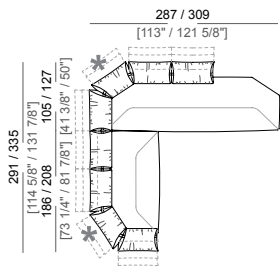

**Composition D**  
Composizione D

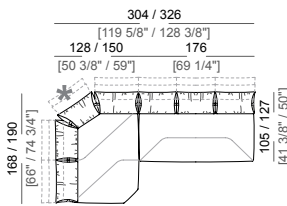

**Composition E**  
Composizione E

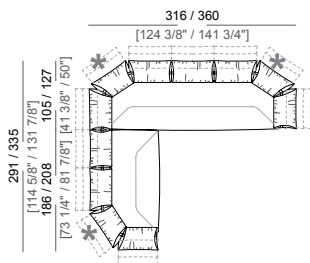

**Composition F**  
Composizione F

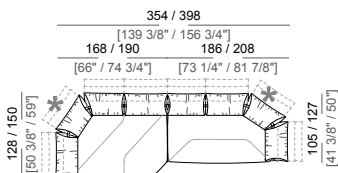

**Composition G**  
Composizione G

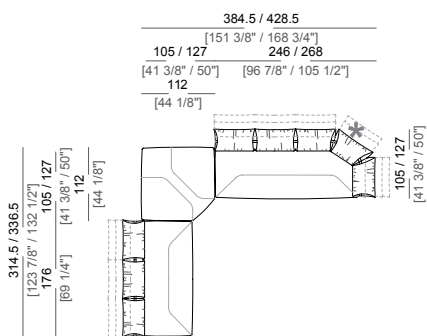

**Composition H**  
Composizione H

