

SIMON

Design: Studio 28



Product description

Upholstered bed covered in fabric, micro nubuck, synthetic leather or soft leather as per sample card.
Slats included. Optional: pull-up slats with container.

SIMON

Design: Studio 28

Dimension

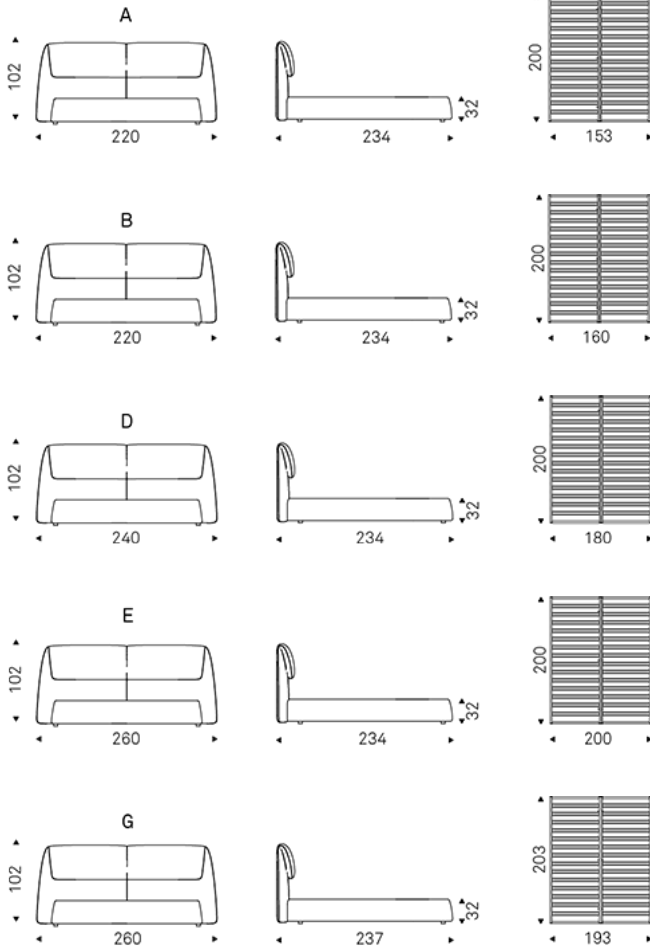

SIMON

Design: Studio 28

Finishes: upholster

soft leather

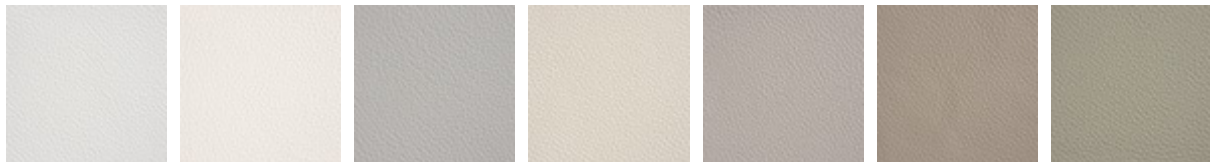

971 BIANCO

937 PALLADIO

972 CANOVA

947 OYSTER

959 ICE

939 NYMPH

949 CENERE

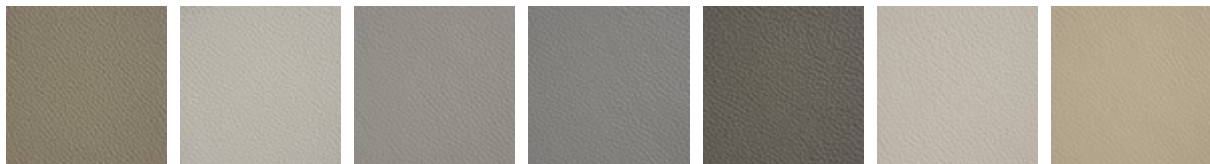

951 CASTORO

993 ARTICO

938 DAKOTA

995 NARDÒ

983 ARGILLA

948 LINO

969 CASHMERE

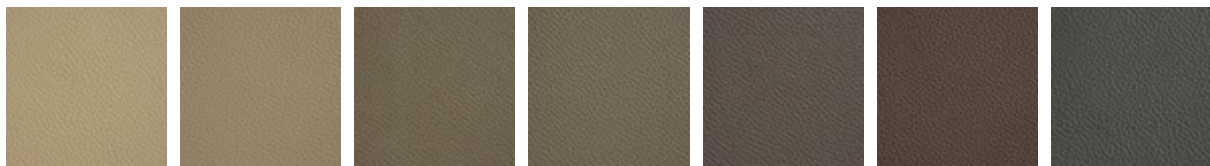

945 SAFARI

950 TORTORA

960 BRUNO

942 FANGO

946 MARRONE

988 TABACCO

952 SMOKE

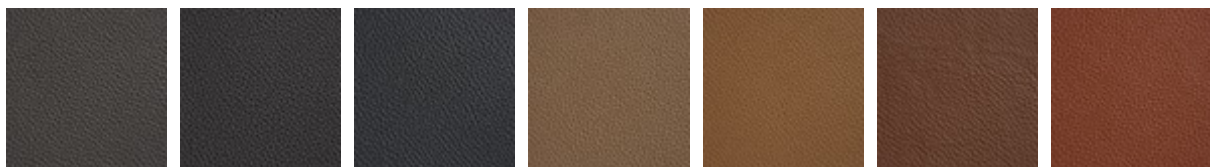

953 ARDESIA

977 PIOMBO

956 ATLANTICO

981 BISCOTTO

982 COGNAC

996 SIENA

994 CANYON

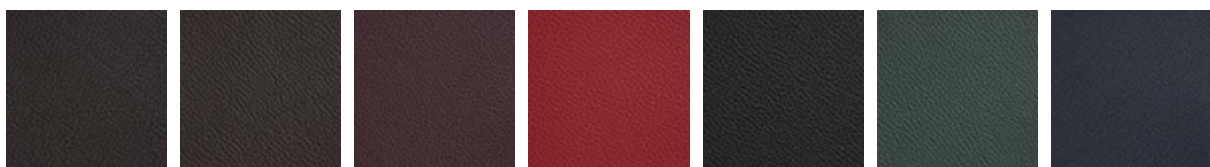

943 MOKA

891 TESTA DI
MORO

944 BORDEAUX

989 ROSSO
CORSA

973 NERO

987 SHERWOOD

940 NAVY

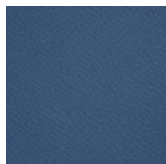

974 CAPRI

fabric



B240 B241 B920 B730 B921 B610 B732

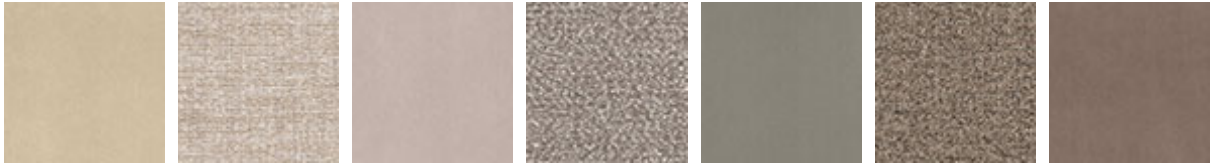

B922 B810 B923 B242 B924 B731 B925



B811 B926 B243 B927 B244 B928 B245



B929 B246 B247 B930 B248 B931 B249



B932 B714 B713 B520 B530 B401 B721



B720 B722 B403 B420 B521 B710 B711



B540 B522 B541 B531 B421 B220 B221

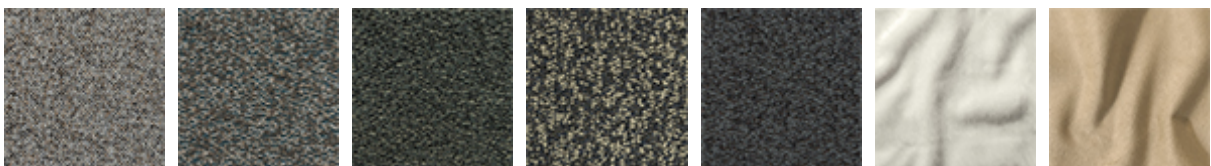

B222 B431 B433 B434 B435 B230 B231



B232

B233

B234

B235

B236

B238

B239

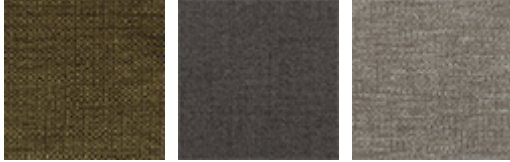

B405

B422

B712

synthetic leather



ECP01 BIANCO

ECP72 CANOVA

ECP47 OYSTER

ECP48 LINO

ECP25 CANAPA

ECP05 TORTORA

ECP26 FANGO



ECP83 ARGILLA

ECP07
MARRONE

ECP27 FOSSIL

ECP08 MOKA

ECP28
KALAMATA

ECP36 CEMENTO

ECP23 LONDON



ECP37 ARDESIA

ECP30 PIOMBO

ECP24 NERO

ECP22 NAVY

ECP14
BORDEAUX

ECP13 ROSSO
CORSA

micro nubuck



MN103 WHITE

MN100 BEIGE

MN806 SAND

MN604 SHADOW

MN006 DUSTY
ROSE

MN413 ALMOND

MN048
SUNSTONE



MN709 MINT

MN801 MUSK

MN603 COGNAC

MN609 MARRON

MN618 LEAD

MN626
CHARCOAL

MN320
CARDINAL

glove soft leather



GLV02 DOVER



GLV03 ECRÙ



GLV05 CORDA



GLV06 MANTA



GLV07 ARGO



GLV11 TAUPE



GLV14 PLATOON



GLV15 CARBON



GLV17 HORNET



GLV12 OLIVA



GLV18 BARRIQUE



GLV16 CACAO