

## HESTON





### Product description

Single or modular sofa with wooden frame, polyurethane seat padding and feather back padding. Feet in titanium (GFM11), bronze (GFM18) or black (GFM73) embossed lacquered metal, available in two heights. Fabric or leather upholstery as per sample card. Removable cover only in the fabric version.

## HESTON

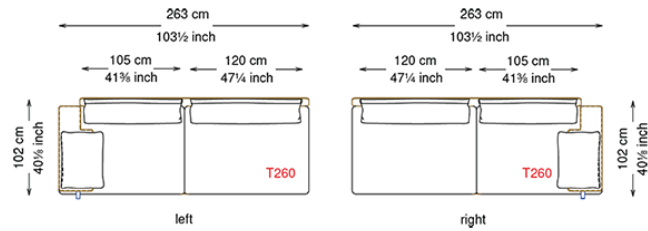
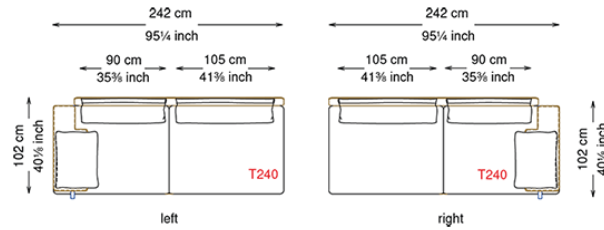
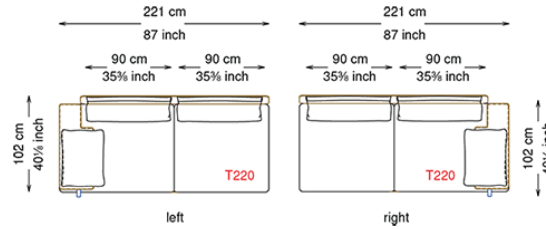
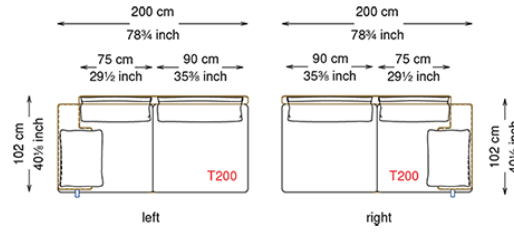
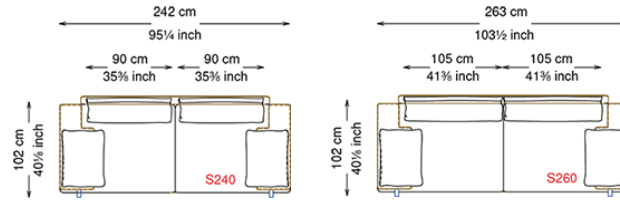
### Dimension



82/86 cm  
 32 1/4 / 33 3/8 inch  
 65/69 cm  
 25 5/8 / 27 1/8 inch  
  
 40/44 cm  
 15 3/4 / 17 3/8 inch

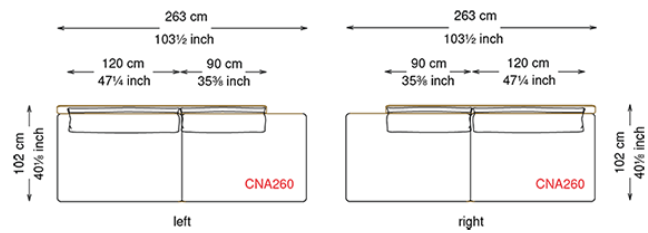
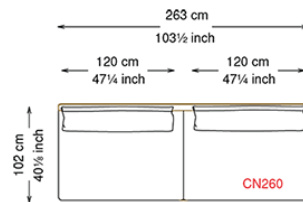
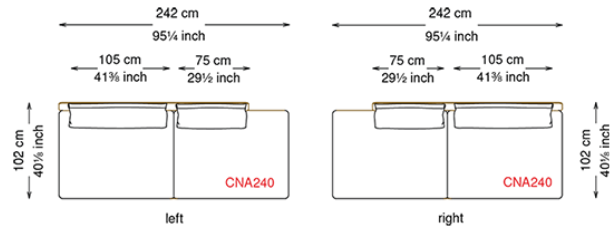
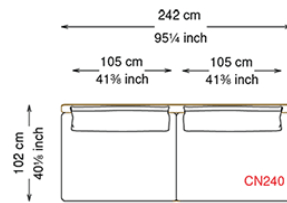
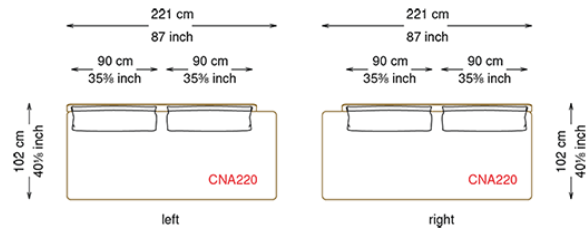
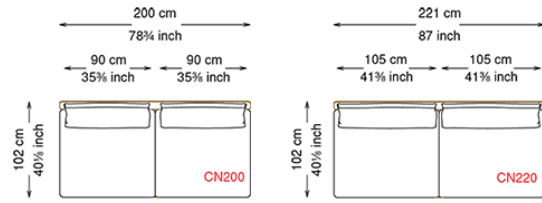

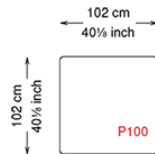
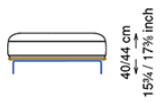
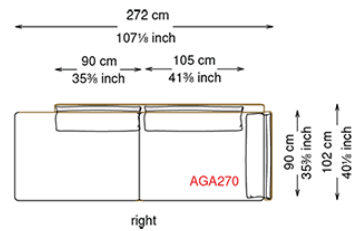
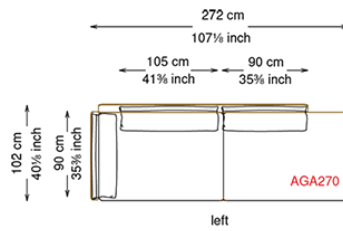
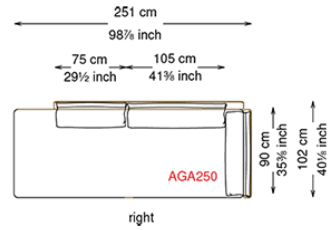
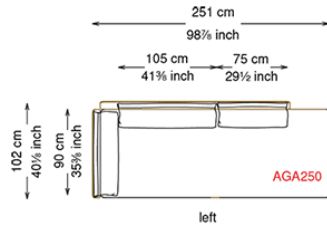
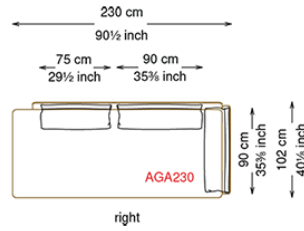
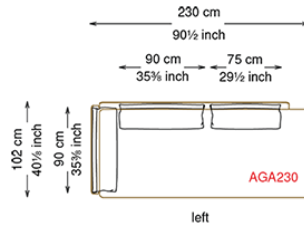
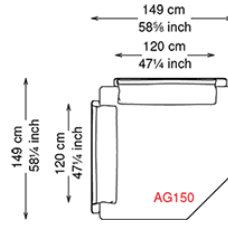
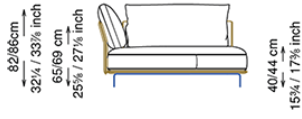

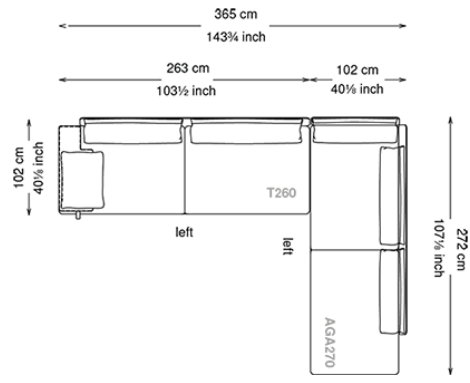
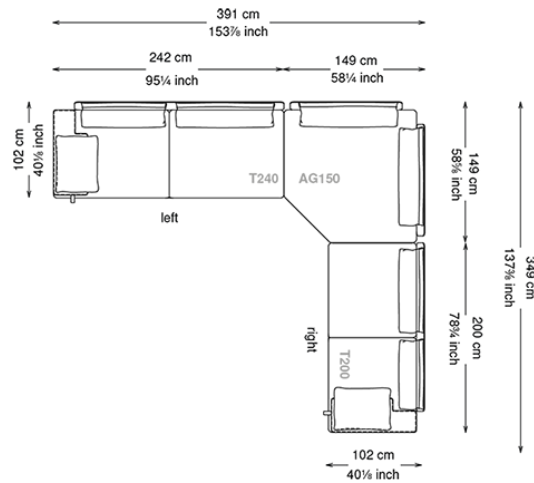
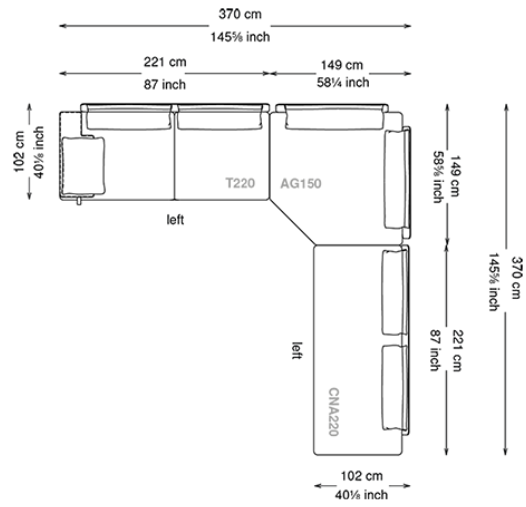

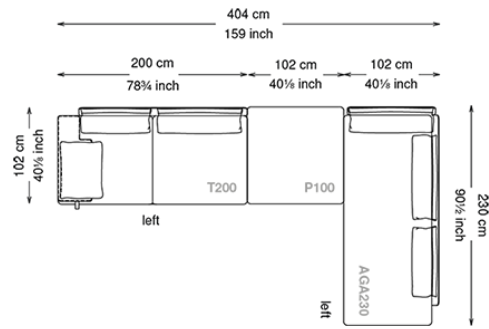

# HESTON

## Finishes: feet

metal

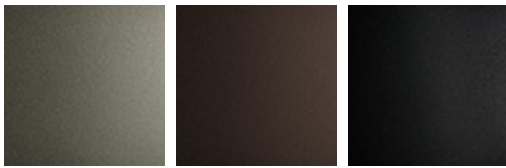

GFM11 titanium embossed

GFM18 bronze embossed

GFM73 black embossed

## Finishes: upholster

T10



D083

B117

F168

F121

F131

A182

A150

B003

B071

F049

B145

D050

B136

B002

B058

B161

B157

D133

T20



T30



T40



T50

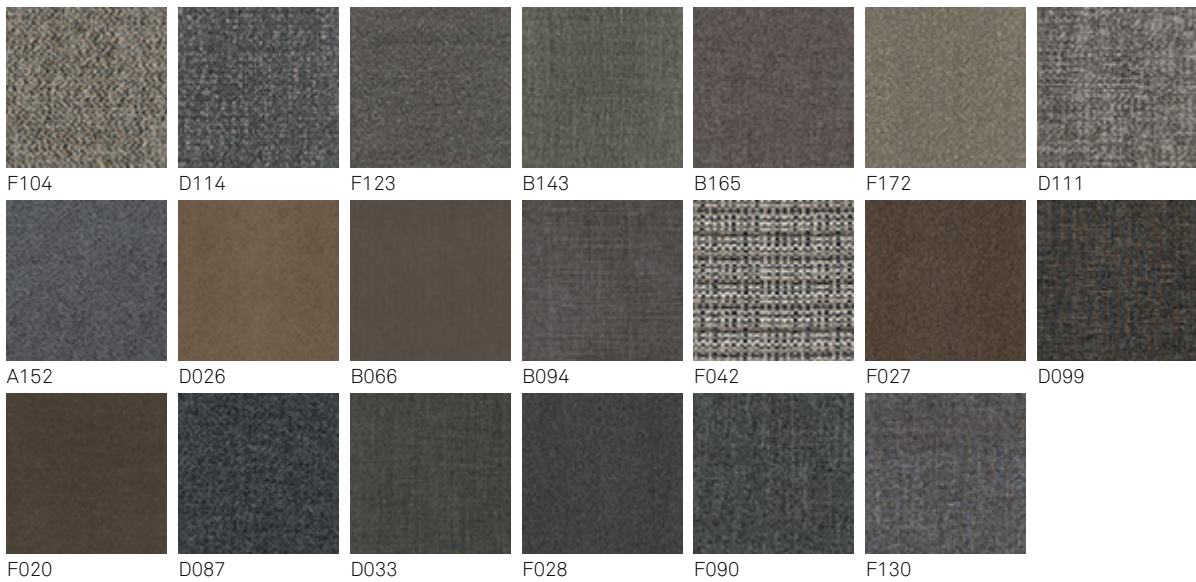

## T60

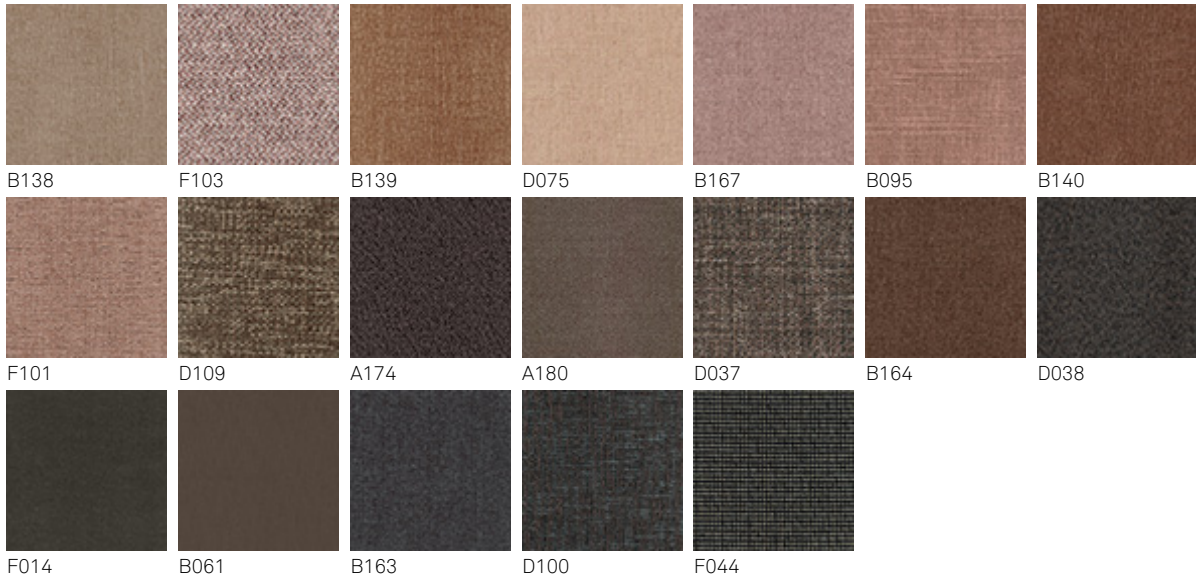

## T70

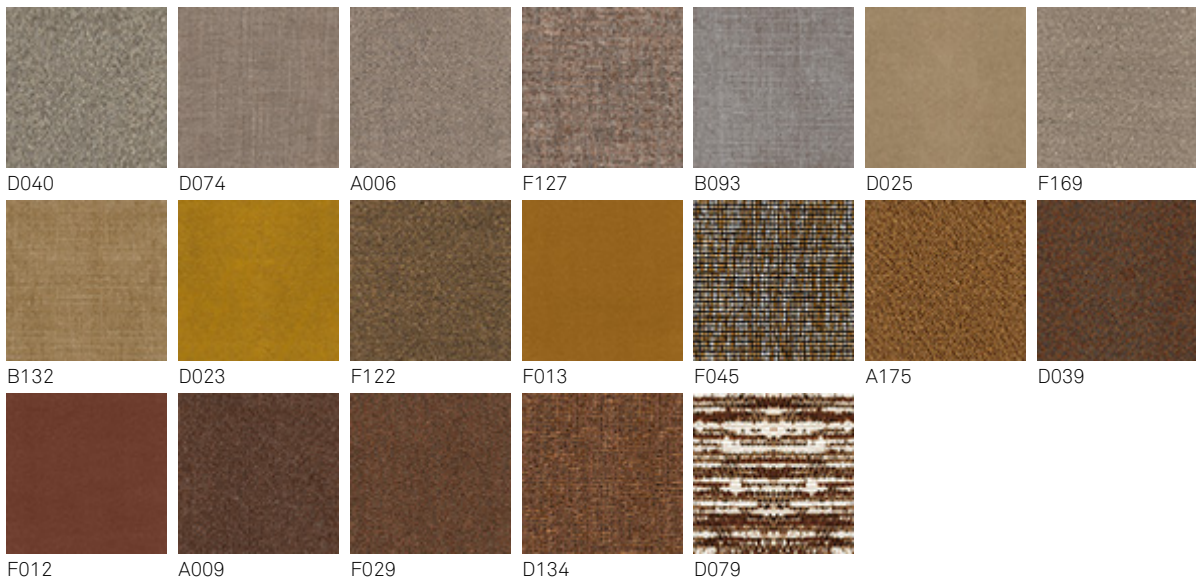

T80

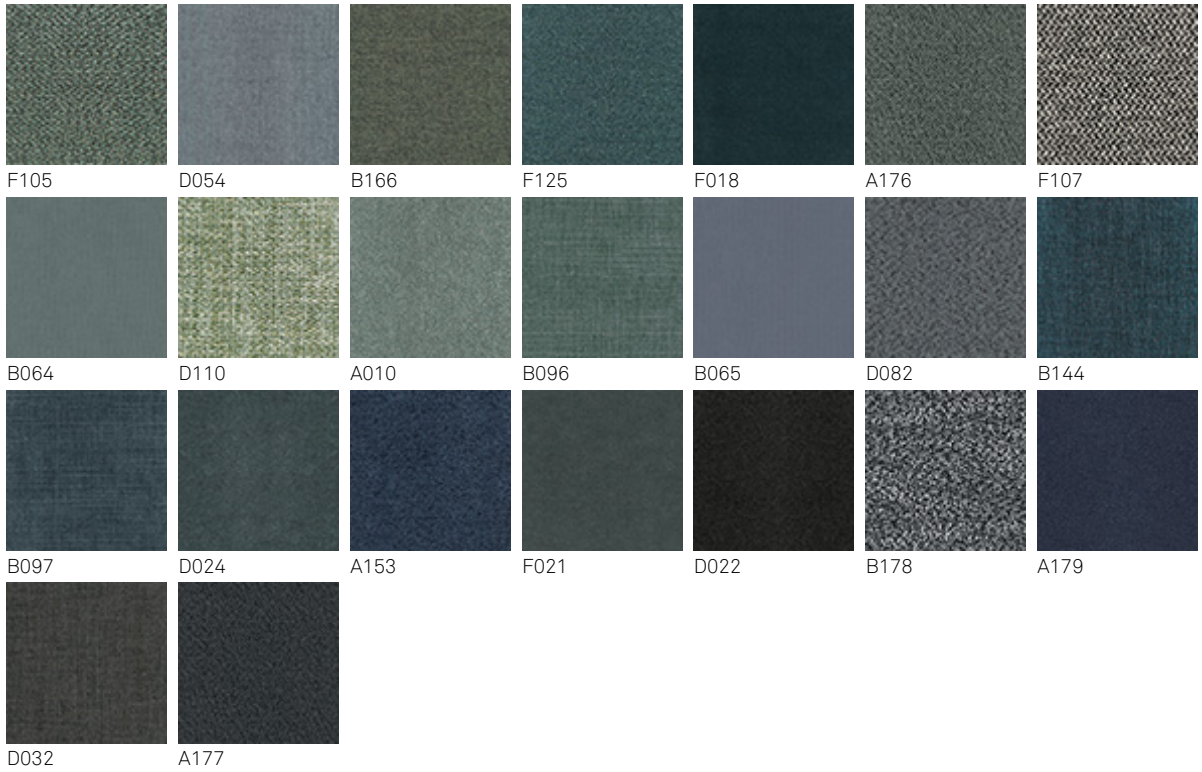

T90

